

version .0

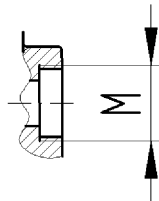
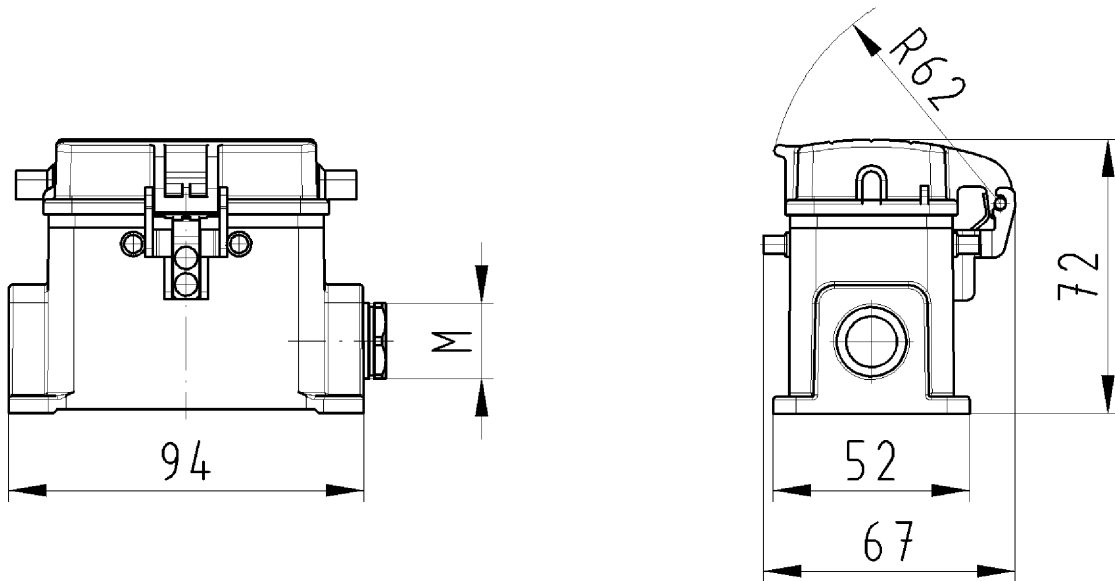

version .1

Zeichnungsnummer
70.341.1035.010W
Gehäuseunterteil

Gehäuseunterteil
70.341.1035.0
72.341.1035.0

20.11.2007
Schreiber Patrick
M 1:2